



www.philips.com/welcome

EN	User manual	1
	Customer care and warranty	30
	Troubleshooting & FAQs	36

Table of Contents

1. Important	1
1.1 Safety precautions and maintenance...	1
1.2 Notational Descriptions.....	2
1.3 Disposal of product and packing material	3
2. Setting up the monitor	4
2.1 Installation.....	4
2.2 Operating the monitor	6
2.3 MHL (Mobile High-Definition Link) introduction	8
2.4 SoftBlue Technology introduction	9
3. Image Optimization	10
3.1 SmartImage Lite.....	10
3.2 SmartContrast.....	11
3.3 Philips SmartControl Lite	11
4. Technical Specifications	18
4.1 Resolution & Preset Modes.....	20
5. Power Management	21
6. Regulatory Information	22
7. Customer care and warranty	30
7.1 Philips' Flat Panel Monitors Pixel Defect Policy	30
7.2 Customer Care & Warranty.....	32
8. Troubleshooting & FAQs	36
8.1 Troubleshooting	36
8.2 SmartControl Lite FAQs.....	37
8.3 General FAQs	38
8.4 MHL FAQs.....	40

1. Important

This electronic user's guide is intended for anyone who uses the Philips monitor. Take time to read this user manual before you use your monitor. It contains important information and notes regarding operating your monitor.

The Philips guarantee applies provided the product is handled properly for its intended use, in accordance with its operating instructions and upon presentation of the original invoice or cash receipt, indicating the date of purchase, dealer's name and model and production number of the product.

1.1 Safety precautions and maintenance

Warnings

Use of controls, adjustments or procedures other than those specified in this documentation may result in exposure to shock, electrical hazards and/or mechanical hazards.

Read and follow these instructions when connecting and using your computer monitor.

Operation

- Please Keep the monitor out of direct sunlight, very strong bright lights and away from any other heat source. Lengthy exposure to this type of environment may result in discoloration and damage to the monitor.
- Remove any object that could fall into ventilation holes or prevent proper cooling of the monitor's electronics.
- Do not block the ventilation holes on the cabinet.
- When positioning the monitor, make sure the power plug and outlet are easily accessible.
- If turning off the monitor by detaching the power cable or DC power cord, wait for 6 seconds before attaching the power cable or DC power cord for normal operation.

- Please use approved power cord provided by Philips all the time. If your power cord is missing, please contact with your local service center. (Please refer to Customer Care Consumer Information Center)
- Do not subject the monitor to severe vibration or high impact conditions during operation.
- Do not knock or drop the monitor during operation or transportation.

Maintenance

- To protect your monitor from possible damage, do not put excessive pressure on the LCD panel. When moving your monitor, grasp the frame to lift; do not lift the monitor by placing your hand or fingers on the LCD panel.
- Unplug the monitor if you are not going to use it for an extensive period of time.
- Unplug the monitor if you need to clean it with a slightly damp cloth. The screen may be wiped with a dry cloth when the power is off. However, never use organic solvent, such as, alcohol, or ammonia-based liquids to clean your monitor.
- To avoid the risk of shock or permanent damage to the set, do not expose the monitor to dust, rain, water, or excessive moisture environment.
- If your monitor gets wet, wipe it with dry cloth as soon as possible.
- If foreign substance or water gets in your monitor, please turn the power off immediately and disconnect the power cord. Then, remove the foreign substance or water, and send it to the maintenance center.
- Do not store or use the monitor in locations exposed to heat, direct sunlight or extreme cold.
- In order to maintain the best performance of your monitor and use it for a longer lifetime, please use the monitor in a location that falls within the following temperature and humidity ranges.

1. Important

- Temperature: 0-40°C 32-95°F
- Humidity: 20-80% RH
- **IMPORTANT:** Always activate a moving screen saver program when you leave your monitor unattended. Always activate a periodic screen refresh application if your monitor will display unchanging static content. Uninterrupted display of still or static images over an extended period may cause "burn in", also known as "after-imaging" or "ghost imaging", on your screen.
- "Burn-in", "after-imaging", or "ghost imaging" is a well-known phenomenon in LCD panel technology. In most cases, the "burned in" or "after-imaging" or "ghost imaging" will disappear gradually over a period of time after the power has been switched off.

Warning

Failure to activate a screen saver, or a periodic screen refresh application may result in severe "burn-in" or "after-image" or "ghost image" symptoms that will not disappear and cannot be repaired. The damage mentioned above is not covered under your warranty.

Service

- The casing cover should be opened only by qualified service personnel.
- If there is any need for any document for repair or integration, please contact with your local service center. (please refer to the chapter of "Consumer Information Center")
- For transportation information, please refer to "Technical Specifications".
- Do not leave your monitor in a car/trunk under direct sun light.

Note

Consult a service technician if the monitor does not operate normally, or you are not sure what procedure to take when the operating instructions given in this manual have been followed.

1.2 Notational Descriptions

The following subsections describe notational conventions used in this document.

Notes, Cautions and Warnings

Throughout this guide, blocks of text may be accompanied by an icon and printed in bold or italic type. These blocks contain notes, cautions or warnings. They are used as follows:

Note

This icon indicates important information and tips that help you make better use of your computer system.

Caution

This icon indicates information that tells you how to avoid either potential damage to hardware or loss of data.

Warning

This icon indicates the potential for bodily harm and tells you how to avoid the problem.

Some warnings may appear in alternate formats and may not be accompanied by an icon. In such cases, the specific presentation of the warning is mandated by the relevant regulatory authority.

1.3 Disposal of product and packing material

Waste Electrical and Electronic Equipment- WEEE



This marking on the product or on its packaging illustrates that, under European Directive 2012/19/EU governing used electrical and electronic appliances, this product may not be disposed of with normal household waste. You are responsible for disposal of this equipment through a designated waste electrical and electronic equipment collection. To determine the locations for dropping off such waste electrical and electronic, contact your local government office, the waste disposal organization that serves your household or the store at which you purchased the product.

Your new monitor contains materials that can be recycled and reused. Specialized companies can recycle your product to increase the amount of reusable materials and to minimize the amount to be disposed of.

All redundant packing material has been omitted. We have done our utmost to make the packaging easily separable into mono materials.

Please find out about the local regulations on how to dispose of your old monitor and packing from your sales representative.

Taking back/Recycling Information for Customers

Philips establishes technically and economically viable objectives to optimize the environmental performance of the organization's product, service and activities.

From the planning, design and production stages, Philips emphasizes the importance of making products that can easily be recycled. At Philips, end-of-life management primarily entails participation in national take-back initiatives and recycling programs whenever possible, preferably in cooperation with competitors, which recycle all materials (products and related packaging material) in accordance with all Environmental Laws and taking back program with the contractor company.

Your display is manufactured with high quality materials and components which can be recycled and reused.

To learn more about our recycling program please visit

<http://www.philips.com/sites/philipsglobal/about/sustainability/ourenvironment/productrecyclingservices.page>

2. Setting up the monitor

2.1 Installation

1 Package contents

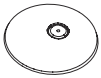
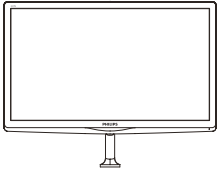

AC/DC Adapter



*VGA

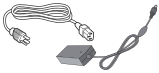

Audio cable

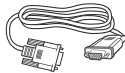

*HDMI



Cable management



*DVI

* Depends on the country

Note

Use only the AC/DC adapter model: Philips ADPC1936

2 Install base stand

1. Place the monitor face down on soft and smooth surface taking care to avoid scratching or damaging the screen.

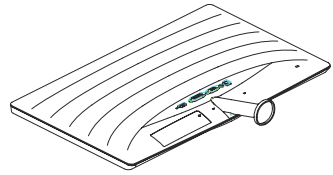

2. Hold the base stand with both hands and firmly insert the base stand into the base column.
 - (1) Gently attach the base to the base column until the latch locks the base.
 - (2) Use your fingers to tighten the screw located at the bottom of the base, and secure the base to the column tightly.

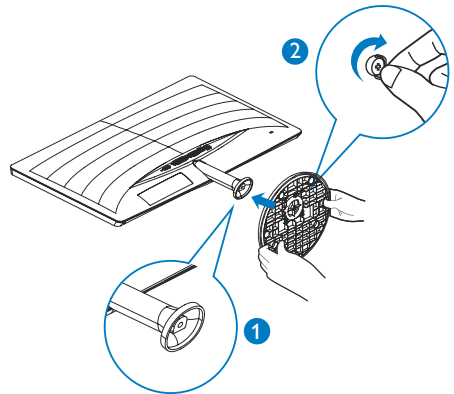

2. Setting up the monitor

3 Connecting to your PC

247E6ESD/247E6ESW:

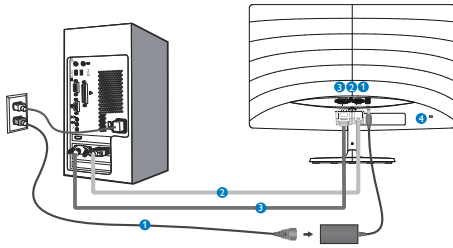

- ❶ AC/DC power input
- ❷ VGA input
- ❸ DVI input
- ❹ Kensington anti-theft lock

Connect to PC

1. Connect the power cord to the back of the monitor firmly.
2. Turn off your computer and unplug its power cable.
3. Connect the monitor signal cable to the video connector on the back of your computer.
4. Plug the power cord of your computer and your monitor into a nearby outlet.
5. Turn on your computer and monitor. If the monitor displays an image, installation is complete.

247E6BDAW/247E6BDAD/247E6EDAW/247E6EDAD :

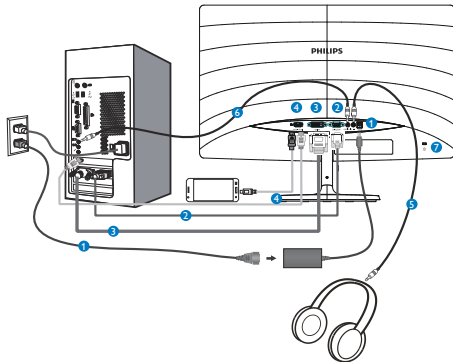

- ❶ AC/DC power input
- ❷ VGA input
- ❸ DVI input
- ❹ HDMI or MHL input
- ❺ Earphone output
- ❻ Audio input
- ❼ Kensington anti-theft lock

2.2 Operating the monitor

1 Front view product description

247E6ESD/247E6ESW:

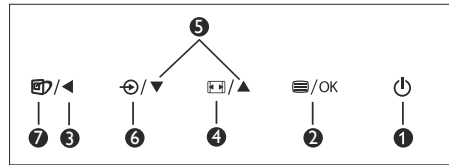
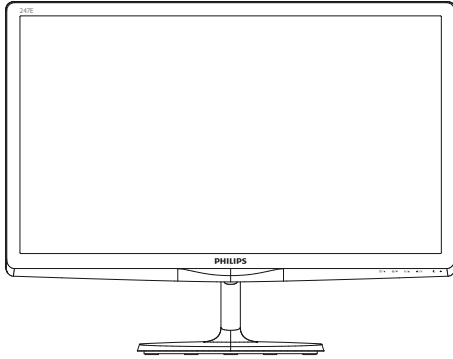

1		Switch monitor's power ON and OFF.
2		Access the OSD menu. Confirm the OSD adjustment.
3		Return to previous OSD level.
4		Change display format.
5		Adjust the OSD menu.
6		Change the signal input source.
7		SmartImage Lite. There are three modes to be selected: <i>Standard</i> , <i>Internet</i> and <i>Game</i> .

247E6BDAD/247E6BDAD/247E6EDAW/247E6EDAD:

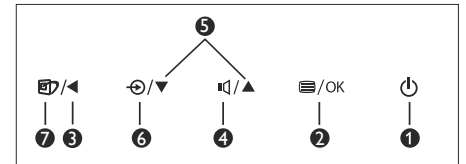
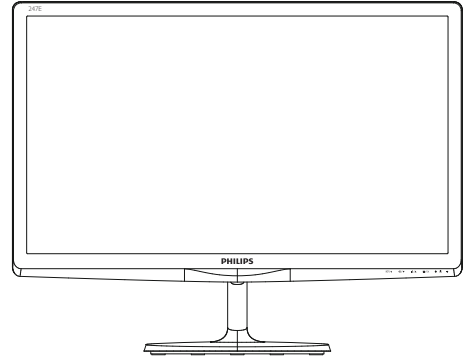

1		Switch monitor's power ON and OFF.
2		Access the OSD menu. Confirm the OSD adjustment.
3		Return to previous OSD level.
4		Adjust the speaker volume.
5		Adjust the OSD menu.
6		Change the signal input source.
7		SmartImage Lite. There are three modes to be selected: <i>Standard</i> , <i>Internet</i> and <i>Game</i> .

2. Setting up the monitor

2 Description of the On Screen Display

What is On-Screen Display (OSD)?

On-Screen Display (OSD) is a feature in all Philips LCD monitors. It allows an end user to adjust screen performance or select functions of the monitors directly through an on-screen instruction window. A user friendly on screen display interface is shown as below:

247E6ESD/247E6ESW:



247E6BDAW/247E6BDAD/247E6EDAW/247E6EDAD:



Basic and simple instruction on the control keys

In the OSD shown above, you can press ▼ ▲ buttons at the front bezel of the monitor to move the cursor; and press OK button to confirm the choice or change.

The OSD Menu

Below is an overall view of the structure of the On-Screen Display. You can use this as a reference when you want to work your way around the different adjustments later on.

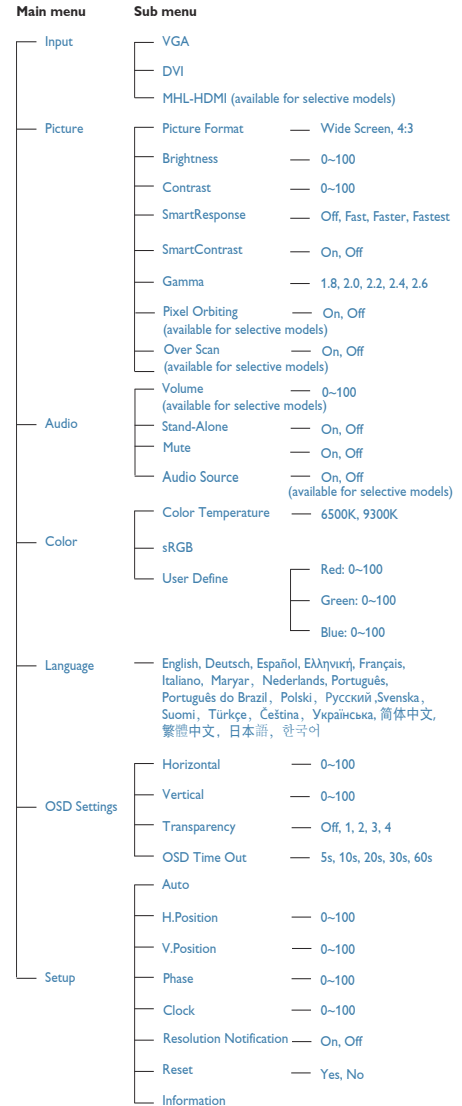

2. Setting up the monitor

3 Resolution notification

This monitor is designed for optimal performance at its native resolution, 1920×1080@60Hz. When the monitor is powered on at a different resolution, an alert is displayed on screen: Use 1920×1080@60Hz for best results.

Display of the native resolution alert can be switched off from Setup in the OSD (On Screen Display) menu.

4 Physical Function

Tilt

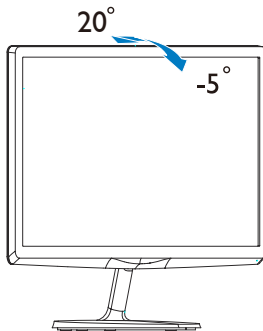

2.3 MHL (Mobile High-Definition Link) introduction

1 What is it?

Mobile High Definition Link (MHL) is a mobile audio/video interface for directly connecting mobile phones and other portable devices to high-definition displays.

An optional MHL cable allows you to simply connect your MHL capable mobile device to this large Philips MHL display, and watch your HD videos come to life with full digital sound. Now not only you can enjoy your mobile games, photos, movies, or other apps on its big screen, you can simultaneously charge your mobile device so you never run out of power half way.

2 How do I use the MHL function?

To use the MHL function, you need an MHL-Certified mobile device. To find a list of MHL-certified devices, visit the official MHL website (<http://www.mhlconsortium.org>)

You also need an optional MHL certified special cable in order to use this function.

3 How does it work? (how do I connect?)

Connect the Optional MHL cable to the mini USB port on the mobile device side, and the [MHL-HDMI] marked port on the monitor side. You are now ready to view the images on your big screen display and operate all function on you the mobile device such as internet surfing, game playing, photo browsing...etc. if your monitor has speaker function, then you will be able to hear accompanying sound too. When the MHL cable is disconnected or the mobile device is turned off, the MHL function will be automatically disabled.

Note

- The port marked [MHL-HDMI] is the only port on the monitor that supports the MHL function when the MHL cable is used. Note that the MHL certified cable is different than a standard HDMI cable.
- A mobile device with MHL certification must be purchased separately
- You may have to manually switch the monitor to MHL-HDMI mode in order to activate the monitor, if you have other devices already working and connected to available inputs
- Standby/Off energy saving of ErP is not applicable for the MHL charging functionality
- This Philips display is MHL certified. However, in case your MHL device does not connect or work correctly, check with your MHL device FAQ or vendor directly for direction. The policy of your device manufacturer may require you to purchase their brand specific MHL cable or adapter in order to work.

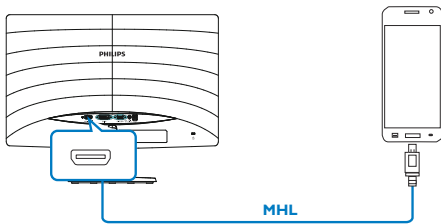

2.4 SoftBlue Technology introduction

With Philips SoftBlue Technology, it Protect your eyes from Blue Light damage. Studies have shown that just as ultra-violet rays can cause eye damage, blue light rays from LED displays can cause damage to different parts of the eye and affect vision over time. Philips SoftBlue feature uses a smart technology to reduce the harmful blue light waves without affecting the color or image of the display.

3. Image Optimization

3.1 SmartImage Lite

1 What is it?

SmartImage Lite provides presets that optimize display for different types of content, dynamically adjusting brightness, contrast, color and sharpness in real time. Whether you're working with text applications, displaying images or watching a video, Philips SmartImage Lite delivers great optimized monitor performance.

2 Why do I need it?

You want a monitor that delivers optimized display all your favorite types of content, SmartImage Lite software dynamically adjust brightness, contrast, color and sharpness in real time to enhance your monitor viewing experience.

3 How does it work?

SmartImage Lite is an exclusive, leading edge Philips technology that analyzes the content displayed on your screen. Based on a scenario you select, SmartImage Lite dynamically enhances the contrast, color saturation and sharpness of images to enhance the contents being displayed - all in real time with the press of a single button.

4 How to enable SmartImage Lite?

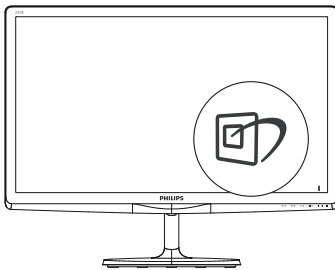

1. Press **RT** to launch the SmartImage Lite on screen display;
2. Keep pressing **▼▲** to toggle between Standard, Internet, Game.

3. The SmartImage Lite on screen display will remain on screen for 5 seconds or you can also press **OK** button to make confirmation.

There are three modes to be selected: Standard, Internet, Game.

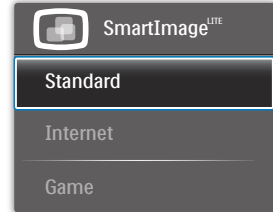

- **Standard:** Enhances text and dampens brightness to increase readability and reduce eye strain. This mode significantly enhances readability and productivity when you're working with spreadsheets, PDF files, scanned articles or other general office applications.
- **Internet:** This profile combines color saturation, dynamic contrast and sharpness enhancement to display photos and other images with outstanding clarity in vibrant colors - all without artifacts and faded colors.
- **Game:** Turn on over drive circuit for best response time, reduce jaggy edges for fast moving objects on screen, enhance contrast ratio for bright and dark scheme, this profile delivers the best gaming experience for gamers.

3.2 SmartContrast

1 What is it?

Unique technology that dynamically analyzes displayed content and automatically optimizes a LCD monitor's contrast ratio for maximum visual clarity and viewing enjoyment, stepping up backlighting for clearer, crisper and brighter images or dimming backlighting for clear display of images on dark backgrounds.

2 Why do I need it?

You want the very best visual clarity and viewing comfort for every type of content. SmartContrast dynamically controls contrast and adjusts backlighting for clear, crisp, bright gaming and video images or displays clear, readable text for office work. By reducing your monitor's power consumption, you save on energy costs and extend the lifetime of your monitor.

3 How does it work?

When you activate SmartContrast, it will analyse the content you are displaying in real time to adjust colors and control backlight intensity. This function will dynamically enhance contrast for a great entertainment experience when viewing videos or playing games.

3.3 Philips SmartControl Lite

The new SmartControl Lite software by Philips allows you to control your monitor via an easy to use on-screen graphic interface. Complicated adjustments are a thing of the past as this user friendly software guides you through fine-tuning resolution, Color calibration, Clock/Phase adjustments, RGB White point adjustment, etc.

Equipped with latest technology in core algorithm for fast processing and response, this Windows compliant eye catching animated Icon based software is ready to enhance your experience with Philips monitors!

1 Installation

- Follow the instruction and complete the installation.
- You can launch after installation is completed.
- If you want to launch later, you can either click the shortcut on desktop or toolbar.



First launch -Wizard

- The first time after installation of SmartControl Lite, it will automatically go to Wizard for first time launch.
- The wizard will guide you through adjustment your monitor performance step by step.
- You can go to Plug-in menu to launch wizard later on as well.
- You can adjust more options without wizard by Standard pane.

3. Image Optimization



2 Start with Standard pane:

Adjust menu:

- Adjust Menu allow you to adjust Brightness, Contrast, Focus, Position and Resolution.
- You can follow the instruction and do the adjustment.
- Cancel prompts user if you want to cancel installation.





Color menu:

- Color Menu allow you to adjust RGB, Black Level, White Point, Color Calibration, and SmartImage Lite (Please refer to SmartImage Lite section).
- You can follow the instruction and do the adjustment.
- Refer to below table for sub-menu item base on your input.
- Example for Color Calibration:



1. "Show Me" starts color calibration tutorial.

3. Image Optimization

2. Start - starts the 6-step color calibration sequence.
3. Quick View loads the before/after images.
4. To return to Color home pane, click the **Cancel** button.
5. Enable color calibration - by default is on. If unchecked, does not allow for color calibration to happen, dimes out start and quick view buttons.
6. Must have patent info in calibration screen.

First color Calibration Screen:



- Previous button is disabled until the second color screen.
- Next goes to the succeeding target (6-targets).
- Final next goes File>Presets pane.
- Cancel closes the UI and returns to the plug in page.

SmartImage Lite

Allows user to change setting for better display setting based on content.

When Entertainment is set, SmartContrast and SmartResponse are enabled.



Options>Preferences - Will only be active when selecting Preferences from the drop-down Options menu. On a non-supported display capable of DDC/CI, only the Help and Options tabs are available.



- Displays current preference settings.
- A checked box enables the feature. The check box is a toggle.
- Enable Context Menu on desktop is checked (On) by default. Enable Context menu displays SmartControl Lite selections for Select Preset and Tune Display in the desktop right-click context menu. Disabled removes SmartControl Lite from the right click context menu.
- Enable Task Tray icon is checked (On) by default. Enable context menu shows the task tray menu for SmartControl Lite. A right click on the task tray icon displays the menu options for Help, Technical Support, Check for Update, About, and Exit. When Enable task tray menu is disabled, the task tray icon will only display EXIT.
- Run at Startup is checked (On) by default. When disabled, SmartControl Lite will not launch at start or be in the task tray. The only way to launch SmartControl Lite is either from the desktop short cut or from the program file. Any preset set to run at startup will not load when this box is unchecked (Disabled).
- Enable transparency mode (Windows 7, Windows 8, Vista, XP). Default is 0% Opaque.

Options>Input - Will only be active when selecting Input from the drop-down Options

menu. On a non-supported display capable of DDC/CI, only the Help and Options tabs are available. All other SmartControl Lite tabs are not available.



- Display the Source instruction pane and current input source setting.
- On single input displays, this pane will not be visible.

Options>Audio - Will only be active when selecting Audio from the drop-down Options menu.

On a non-supported display capable of DDC/CI, only the Help and Options tabs are available.



3. Image Optimization

Help>User Manual - Will only be active when selecting User Manual from the drop-down Help menu. On a non-supported display capable of DDC/CI, only the Help and Options tabs are available.



Help>Version - Will only be active when selecting Version from the drop-down Help menu. On a non-supported display capable of DDC/CI, only the Help and Options tabs are available.



Context Sensitive menu

The Context Sensitive menu is Enabled by default. If Enable Context Menu has been checked in the Options>Preferences pane, then the menu will be visible.



The Context Menu has four entries:

- SmartControl Lite - When selected the About Screen is displayed.
- Select Preset - Provides a hierarchical menu of saved presets for immediate use. A check mark shows the currently selected preset. Factory Preset can also be called from the drop down menu.
- Tune Display - Opens the SmartControl Lite control panel.
- SmartImage Lite - Check current settings, Standard, Internet, Game.

Task Tray Menu Enabled

The task tray menu can be displayed by right-clicking on the SmartControl Lite icon from the task tray. Left Click will launch the application.



The task tray has five entries:

- Help - Access to User Manual file: Open User Manual file using the default browser window.
- Technical Support - displays the tech support page.
- Check for Update - takes the user to PDI Landing and checks the user's version against the most current available.

3. Image Optimization

- About - Displays detailed reference information: product version, release information, and product name.
- Exit - Close SmartControl Lite.

To run SmartControl Lite again either select SmartControl Lite from Program menu, double-click the desktop PC icon or restart the system.



Task Tray Menu Disabled



When the Task Tray is disabled in the preference folder, only the EXIT selection is available.

To completely remove SmartControl Lite from the task tray, disable Run at Startup in Options>Preferences.

Note

All the illustrations in this section are for reference only. SmartControl software version might be changed without notification. Please always check official Portrait website www.portrait.com/dtune/phl/enu/index to download the latest version of SmartControl software.

4. Technical Specifications

Picture/Display	
Monitor Panel Type	TFT LCD(247E6BDAW/247E6BDAD); IPS-ADS LCD(247E6ESD/247E6ESW/247E6EDAW/247E6EDAD)
Backlight	LED
Panel Size	23.6" W (59.9cm)
Aspect Ratio	16:9
Pixel Pitch	0.272 x 0.272 mm
Brightness	250 cd/m ²
SmartContrast	20,000,000:1
Contrast Ratio (typ.)	1000:1
Response Time (typ.)	14ms(247E6ESD/247E6ESW/247E6EDAW/247E6EDAD) 5ms(247E6BDAW/247E6BDAD)
SmartResponse	5ms(GtG)(247E6ESD/247E6ESW/247E6EDAW/247E6EDAD) 2ms(GtG)(247E6BDAW/247E6BDAD)
Optimum Resolution	1920x1080 @ 60Hz
Viewing Angle	178° (H) / 178° (V) @ C/R > 10 (247E6ESD/247E6ESW/247E6EDAW/ 247E6EDAD) 170° (H) / 160° (V) @ C/R > 10 (247E6BDAW/247E6BDAD)
Picture Enhancement	SmartImage Lite
Display Colors	16.7M
Vertical Refresh Rate	56Hz - 75Hz
Horizontal Frequency	30kHz - 83kHz
MHL	1080P @ 30Hz (247E6BDAW/247E6BDAD/247E6EDAW/247E6EDAD)
sRGB	YES
SoftBlue	YES
Connectivity	
Signal Input	247E6ESD/247E6ESW:VGA(Analog), DVI(Digital,HDCP) 247E6BDAW/247E6BDAD/247E6EDAW/247E6EDAD: VGA(Analog), DVI(Digital,HDCP), MHL-HDMI(Digital,HDCP)
Audio In/Out	247E6BDAW/247E6BDAD/247E6EDAW/247E6EDAD: PC audio-in, Earphone out, HDMI audio out
Input Signal	Separate Sync, Sync on Green
Convenience	
User Convenience	247E6ESD/247E6ESW:  247E6BDAW/247E6BDAD/247E6EDAW/247E6EDAD: 
OSD Languages	English, German, Spanish, Greek, French, Italian, Hungarian, Dutch, Portuguese, Brazil Portuguese, Polish, Russian, Swedish, Finnish, Turkish, Czech, Ukrainian, Simplified Chinese, Traditional Chinese, Japanese, Korean

4. Technical Specifications

Other Convenience	Kensington Lock
Plug & Play Compatibility	DDC/CI, sRGB, Windows 8/7/Vista/XP, Mac OSX, Linux
Stand	
Tilt	-5° / +20°

247E6B/247E6E:

Power	
On Mode	247E6ESD/247E6ESW: 19.46 W(typ.), 20.88 W(max.) 247E6BDAD/247E6BDAD: 19.72 W(typ.), 32.79 W(max.) 247E6EDAW/247E6EDAD: 22.82 W(typ.), 26.70 W(max.)
Sleep (typ.)	0.5W
Off (typ.)	0.3W
Power LED indicator	On mode: White, Standby/Sleep mode: White (blinking)
Power Supply	External, 100-240VAC, 50-60Hz

Dimension	
Product with stand (WxHxD)	561 x 429 x 212 mm
Product without stand (WxHxD)	561 x 347 x 43 mm

Weight	
Product with stand	3.65kg
Product without stand	3.27kg

Operating Condition	
Temperature range (operation)	0°C to 40 °C
Temperature range (Non-operation)	-20°C to 60°C
Relative humidity	20% to 80%
MTBF	50,000hrs

Environmental	
ROHS	YES
EPEAT	Silver (www.epeat.net)
Packaging	100% recyclable
Specific Substances	100% PVC BFR free housing
Energy Star	YES

Compliance and standards	
Regulatory Approvals	247E6ESD/247E6ESW/247E6BDAD/247E6BDAD/247E6EDAW/247E6EDAD: CE Mark, FCC Class B, CU-EAC, SEMKO, TCO Certified, ETL, BSMI, ISO9241-307, SASO, KUCAS, EPA, VCCI CLASS B, C-TICK CLASS B

Cabinet	
Color	BlackCherry / White
Finish	Glossy

Note

1. EPEAT Gold or Silver is valid only where Philips registers the product. Please visit www.epeat.net for registration status in your country.
2. This data is subject to change without notice. Go to www.philips.com/support to download the latest version of leaflet.
3. Smart response time is the optimum value from either GtG or GtG (BW) tests.

4.1 Resolution & Preset Modes**1 Maximum Resolution**

1920×1080@60Hz (analog input)
1920×1080@60Hz (digital input)

2 Recommended Resolution

1920×1080@60Hz (digital input)

H. freq (kHz)	Resolution	V. freq (Hz)
31.47	720×400	70.09
31.47	640×480	59.94
35.00	640×480	66.67
37.86	640×480	72.81
37.50	640×480	75.00
37.88	800×600	60.32
46.88	800×600	75.00
48.36	1024×768	60.00
60.02	1024×768	75.03
63.89	1280×1024	60.02
79.98	1280×1024	75.03
55.94	1440×900	59.89
70.64	1440×900	74.98
65.29	1680×1050	59.95
67.50	1920×1080	60.00

Note

Please notice that your display works best at native resolution of 1920×1080@60Hz. For best display quality, please follow this resolution recommendation.

5. Power Management

If you have VESA DPM compliance display card or software installed in your PC, the monitor can automatically reduce its power consumption when not in use. If an input from a keyboard, mouse or other input device is detected, the monitor will 'wake up' automatically. The following table shows the power consumption and signaling of this automatic power saving feature:

247E6ESW/247E6ESD:

Power Management Definition					
VESA Mode	Video	H-sync	V-sync	Power Used	LED Color
Active	ON	Yes	Yes	19.46 W (typ.) 20.88 W(Max.)	White
Sleep	OFF	No	No	0.5 W (typ.)	White (blink)
Switch Off	OFF	-	-	0.3 W (typ.)	OFF

247E6BDAW/247E6BDAD:

Power Management Definition					
VESA Mode	Video	H-sync	V-sync	Power Used	LED Color
Active	ON	Yes	Yes	19.72 W (typ.) 32.79 W(Max.)	White
Sleep	OFF	No	No	0.5 W (typ.)	White (blink)
Switch Off	OFF	-	-	0.3 W (typ.)	OFF

247E6EDAW/247E6EDAD:

Power Management Definition					
VESA Mode	Video	H-sync	V-sync	Power Used	LED Color
Active	ON	Yes	Yes	22.82 W (typ.) 26.70 W(Max.)	White
Sleep	OFF	No	No	0.5 W (typ.)	White (blink)
Switch Off	OFF	-	-	0.3 W (typ.)	OFF

The following setup is used to measure power consumption on this monitor:

- Native resolution: 1920x1080
- Contrast: 50%
- Brightness: 250 nits;

- Color temperature: 6500k with full white pattern



Note

This data is subject to change without notice.

6. Regulatory Information

Lead-free Product



Lead free display promotes environmentally sound recovery and disposal of waste from electrical and electronic equipment. Toxic substances like Lead has been eliminated and compliance with European community's stringent RoHs directive mandating restrictions on hazardous substances in electrical and electronic equipment have been adhered to in order to make Philips monitors safe to use throughout its life cycle.

Congratulations!

This product is designed for both you and the planet!



TCO Development works for sustainable IT - manufacture, use and recycling of IT products reflecting environmental, social and economic responsibility.

TCO Certified is a third party verified program, where every product model is tested by an accredited impartial test laboratory. TCO Certified represents one of the toughest certifications for ICT products worldwide.

Some of the Usability features of TCO Certified Displays:

- Visual Ergonomics for image quality is tested to ensure top performance and reduce sight and strain problems. Important parameters are Resolution, Luminance, Contrast, Reflection and Colour characteristics
- Products are tested according to rigorous safety standards at impartial laboratories
- Electric and magnetic fields emissions as low as normal household background levels
- Workload ergonomics to ensure a good physical environment

Some of the Environmental features of TCO Certified Displays:

- Production facilities have an Environmental Management System (EMAS or ISO 14001)
- Low energy consumption to minimize climate impact
- Restrictions on Chlorinated and Brominated flame retardants, plasticizers, plastics and heavy metals such as cadmium, mercury and lead (RoHS compliance)
- Both product and product packaging is prepared for recycling
- The brand owner offers take-back options

Corporate Social Responsibility

- The brand owner demonstrates the product is manufactured under working practices that promote good labour relations and working conditions.

The Criteria Document can be downloaded from our web site. The criteria included in this label have been developed by TCO Development in co-operation with scientists, experts, users as well as manufacturers all over the world. Since the end of the 1980s TCO has been involved in influencing the development of IT equipment in a more user and environmentally friendly direction. Our ICT product labeling system began in 1992 and is now requested by users and ICT-manufacturers all over the world.

For displays with glossy bezels, the user should consider the placement of the display as the bezel may cause disturbing reflections from surrounding light and bright surfaces.

For more information, please visit: www.tcodevelopment.com



Technology for you and the planet

(Only for selective models)

User mode is used for TCO Certified compliance.

EPEAT

(www.epeat.net)



The EPEAT (Electronic Product Environmental Assessment Tool) program evaluates computer

desktops, laptops, and monitors based on 51 environmental criteria developed through an extensive stakeholder consensus process supported by US EPA.

EPEAT system helps purchasers in the public and private sectors evaluate, compare and select desktop computers, notebooks and monitors based on their environmental attributes. EPEAT also provides a clear and consistent set of performance criteria for the design of products, and provides an opportunity for manufacturers to secure market recognition for efforts to reduce the environmental impact of its products.

Benefits of EPEAT

Reduce use of primary materials
Reduce use of toxic materials

Avoid the disposal of hazardous waste EPEAT'S requirement that all registered products meet ENERGY STAR's energy efficiency specifications, means that these products will consume less energy throughout their life.

CE Declaration of Conformity

This product is in conformity with the following standards

- EN60950-1:2006+A11:2009+A1:2010+A12:2011+A2:2013 (Safety requirement of Information Technology Equipment).
- EN55022:2010(Radio Disturbance requirement of Information Technology Equipment).
- EN55024:2010 (Immunity requirement of Information Technology Equipment).
- EN61000-3-2:2006+A1:2009+A2:2009 (Limits for Harmonic Current Emission).
- EN61000-3-3:2008 (Limitation of Voltage Fluctuation and Flicker).
- EN50581:2012 (Technical documentation for the assessment of electrical and electronic products with respect to the restriction of hazardous substances)
- EN 50564:2011 (Electrical and electronic household and office equipment — Measurement of low power consumption)

following provisions of directives applicable

- 2006/95/EC (Low Voltage Directive).
- 2004/108/EC (EMC Directive).
- 2009/125/EC (ErP, Energy-related Product Directive, EC No. 1275/2008 and 642/2009 Implementing)
- 2011/65/EU (RoHS Directive) and is produced by a manufacturing organization on ISO9000 level

And is produced by a manufacturing organization on ISO9000 level.

- ISO9241-307:2008 (Ergonomic requirement, Analysis and compliance test methods for electronic visual displays).
- TCO CERTIFIED (Requirement for Environment Labeling of Ergonomics, Energy, Ecology and Emission, TCO: Swedish Confederation of Professional Employees) for TCO versions.

Energy Star Declaration

(www.energystar.gov)



As an ENERGY STAR® Partner, we have determined that this product meets the ENERGY STAR® guidelines for energy efficiency.

Note

We recommend you switch off the monitor when it is not in use for a long time.

Federal Communications Commission (FCC) Notice (U.S. Only)

This equipment has been tested and found to comply with the limits for a Class B digital device, pursuant to Part 15 of the FCC Rules. These limits are designed to provide reasonable protection against harmful interference in a residential installation. This equipment generates, uses and can radiate radio frequency energy and, if not installed and used in accordance with the instructions, may cause harmful interference to radio communications.

However, there is no guarantee that interference will not occur in a particular installation. If this equipment does cause harmful interference to radio or television reception, which can be determined by turning the equipment off and on, the user is encouraged to try to correct the interference by one or more of the following measures:

- Reorient or relocate the receiving antenna.
- Increase the separation between the equipment and receiver.
- Connect the equipment into an outlet on a circuit different from that to which the receiver is connected.
- Consult the dealer or an experienced radio/TV technician for help.

⚠ Changes or modifications not expressly approved by the party responsible for compliance could void the user's authority to operate the equipment.

Use only RF shielded cable that was supplied with the monitor when connecting this monitor to a computer device.

To prevent damage which may result in fire or shock hazard, do not expose this appliance to rain or excessive moisture.

THIS CLASS B DIGITAL APPARATUS MEETS ALL REQUIREMENTS OF THE CANADIAN INTERFERENCE-CAUSING EQUIPMENT REGULATIONS.

FCC Declaration of Conformity

Declaration of Conformity for Products Marked with FCC Logo,

United States Only



This device complies with Part 15 of the FCC Rules. Operation is subject to the following two conditions: (1) this device may not cause harmful interference, and (2) this device must accept any interference received, including interference that may cause undesired operation.

Commission Federale de la Communication (FCC Declaration)

⚠ Cet équipement a été testé et déclaré conforme aux limites des appareils numériques de class B, aux termes de l'article 15 Des règles de la FCC. Ces limites sont conçues de façon à fournir une protection raisonnable contre les interférences nuisibles dans le cadre d'une installation résidentielle.

CET appareil produit, utilise et peut émettre des hyperfréquences qui, si l'appareil n'est pas installé et utilisé selon les consignes données, peuvent causer des interférences

6. Regulatory Information

nuisibles aux communications radio. Cependant, rien ne peut garantir l'absence d'interférences dans le cadre d'une installation particulière. Si cet appareil est la cause d'interférences nuisibles pour la réception des signaux de radio ou de télévision, ce qui peut être décelé en fermant l'équipement, puis en le remettant en fonction, l'utilisateur pourrait essayer de corriger la situation en prenant les mesures suivantes:

- Réorienter ou déplacer l'antenne de réception.
 - Augmenter la distance entre l'équipement et le récepteur.
 - Brancher l'équipement sur un autre circuit que celui utilisé par le récepteur.
 - Demander l'aide du marchand ou d'un technicien chevronné en radio/télévision.
- ❗ Toutes modifications n'ayant pas reçu l'approbation des services compétents en matière de conformité est susceptible d'interdire à l'utilisateur l'usage du présent équipement.

N'utiliser que des câbles RF armés pour les connections avec des ordinateurs ou périphériques.

CET APPAREIL NUMERIQUE DE LA CLASSE B RESPECTE TOUTES LES EXIGENCES DU REGLEMENT SUR LE MATERIEL BROUILLEUR DU CANADA.

EN 55022 Compliance (Czech Republic Only)



Polish Center for Testing and Certification Notice

The equipment should draw power from a socket with an attached protection circuit (a three-prong socket). All equipment that works together (computer; monitor; printer; and so on) should have the same power supply source.

The phasing conductor of the room's electrical installation should have a reserve short-circuit protection device in the form of a fuse with a nominal value no larger than 16 amperes (A).

To completely switch off the equipment, the power supply cable must be removed from the power supply socket, which should be located near the equipment and easily accessible.

A protection mark "B" confirms that the equipment is in compliance with the protection usage requirements of standards PN-93/T-42107 and PN-89/E-06251.

Wykazanie Polskiego Centrum Badaw i Certyfikacji

Urządzenie powinno być zasilane z gniazda z przyłączonym urządzeniem zabezpieczającym przed porażeniem (gniazdo z trzypiętowym przewodem ochronnym).

Wszystkie urządzenia, które pracują jednocześnie (komputer, monitor, drukarka i inne urządzenia), powinny być zasilane z tego samego źródła zasilania.

Przewód fazowy instalacji elektrycznej w pomieszczeniu powinien być wyposażony w urządzenie zabezpieczające przed zwarciem o wartości nominalnej nie większej niż 16 amperów (A).

Pozostałe instrukcje bezpieczeństwa

1. Urządzenie należy zasilanie z gniazda z przyłączonym urządzeniem zabezpieczającym przed porażeniem (gniazdo z trzypiętowym przewodem ochronnym).
2. Wszystkie urządzenia, które pracują jednocześnie (komputer, monitor, drukarka i inne urządzenia), powinny być zasilane z tego samego źródła zasilania.
3. Przewód fazowy instalacji elektrycznej w pomieszczeniu powinien być wyposażony w urządzenie zabezpieczające przed zwarciem o wartości nominalnej nie większej niż 16 amperów (A).
4. Aby całkowicie wyłączyć urządzenie, należy odłączyć kabel zasilający od gniazda zasilania.
5. Urządzenie należy zasilanie z gniazda z przyłączonym urządzeniem zabezpieczającym przed porażeniem (gniazdo z trzypiętowym przewodem ochronnym).
6. Wszystkie urządzenia, które pracują jednocześnie (komputer, monitor, drukarka i inne urządzenia), powinny być zasilane z tego samego źródła zasilania.

North Europe (Nordic Countries) Information

Placering/Ventilation
VARNING:
FÖRSÄKRA DIG OM ATT HUVUDBRYTARE
OCH UTTAG ÄR LÄTÅTKOMLIGA, NÄR
DU STÄLLER DIN UTRUSTNING PÅPLATS.

Placering/Ventilation
ADVARSEL:
SØRG VED PLACERINGEN FOR, AT
NETLEDNINGENS STIK OG STIKKONTAKT
ER NEMT TILGÆNGELIGE.

Paikka/Ilmankierto
VAROITUS:
SIJOITA LAITE SITEN, ETTÄ VERKKOJOHTO
VOIDAAN TARVITTAESSA HELPOSTI
IRROTTAA PISTORASIESTA.

Plassering/Ventilasjon
ADVARSEL:
NÅR DETTE UTSTYRET PLASSERES, MÅ
DU PASSE PÅ AT KONTAKTENE FOR
STØMTILFØRSEL ER LETTE Å NÅ.

BSMI Notice (Taiwan Only)

符合乙類資訊產品之標準

Ergonomie Hinweis (nur Deutschland)

Der von uns gelieferte Farbmonitor entspricht den in der "Verordnung über den Schutz vor Schäden durch Röntgenstrahlen" festgelegten Vorschriften.

Auf der Rückwand des Gerätes befindet sich ein Aufkleber, der auf die Unbedenklichkeit der Inbetriebnahme hinweist, da die Vorschriften über die Bauart von Störstrahlern nach Anlage III \square 5 Abs. 4 der Röntgenverordnung erfüllt sind.

Damit Ihr Monitor immer den in der Zulassung geforderten Werten entspricht, ist darauf zu achten, daß

1. Reparaturen nur durch Fachpersonal durchgeführt werden.
2. nur original-Ersatzteile verwendet werden.
3. bei Ersatz der Bildröhre nur eine bauartgleiche eingebaut wird.

Aus ergonomischen Gründen wird empfohlen, die Grundfarben Blau und Rot nicht auf dunklem Untergrund zu verwenden (schlechte Lesbarkeit und erhöhte Augenbelastung bei zu geringem Zeichenkontrast wären die Folge).
Der arbeitsplatzbezogene Schalldruckpegel nach DIN 45 635 beträgt 70dB (A) oder weniger.

-  **ACHTUNG: BEIM AUFSTELLEN
DIESES GERÄTES DARAUFG
ACHTEN, DAß NETZSTECKER UND
NETZKABELANSCHLUß LEICHT
ZUGÄNGLICH SIND.**

6. Regulatory Information

China RoHS

The People's Republic of China released a regulation called "Management Methods for Controlling Pollution by Electronic Information Products" or commonly referred to as China RoHS. All products including CRT and Monitor which are produced and sold for China market have to meet China RoHS request.

中国大陆 RoHS

根据中国大陆《电子信息产品污染控制管理办法》(也称为中国大陆 RoHS), 以下部分列出了本产品中可能包含的有毒有害物质或元素的名称和含量

本表适用之产品

显示器(液晶及 CRT)

有毒有害物质或元素

部件名称	有毒有害物质或元素					
	铅 (Pb)	汞 (Hg)	镉 (Cd)	六价铬 (Cr6+)	多溴联苯 (PBB)	多溴二苯醚 (PBDE)
外壳	○	○	○	○	○	○
CRT 显示屏	✕	○	○	○	○	○
液晶显示屏 / 灯管	✕	○	○	○	○	○
电路板组件*	✕	○	○	○	○	○
电源适配器	✕	○	○	○	○	○
电源线 / 连接线	✕	○	○	○	○	○

*: 电路板组件包括印刷电路板及其构成的零部件, 如电阻、电容、集成电路、连接器等
 ○: 表示该有毒有害物质在该部件所有均质材料中的含量均在《电子信息产品中有毒有害物质的限量要求标准》规定的限量要求以下
 ✕: 表示该有毒有害物质至少在该部件的某一均质材料中的含量超出《电子信息产品中有毒有害物质的限量要求标准》规定的限量要求, 但是上表中打“✕”的部件, 符合欧盟 RoHS 法规要求(属于豁免的部分)



环保使用期限

此标识指期限(十年), 电子信息产品中含有的有毒有害物质或元素在正常使用的条件下不会发生外泄或突变, 电子信息产品用户使用该电子信息产品不会对环境造成严重污染或对其人身、财产造成严重损害的期限。

中国能源效率标识

根据中国大陆《能源效率标识管理办法》本显示器符合以下要求:

能源效率 (cd/W)	> 1.05
关闭状态能耗 (W)	< 0.5
能效等级	1 级
能效标准	GB 21520-2008

详细有关信息请查阅中国能效标识网: <http://www.energylabel.gov.cn/>

《废弃电器电子产品回收处理管理条例》提示性说明

为了更好地关爱及保护地球, 当用户不再需要此产品或产品寿命终止时, 请遵守国家废弃电器电子产品回收处理相关法律法规, 将其交给当地具有国家认可的回收处理资质的厂商进行回收处理。

EU Energy Label



The European Energy Label informs you on the energy efficiency class of this product. The greener the energy efficiency class of this product is the lower the energy it consumes. On the label, you can find the energy efficiency class, the average power consumption of this product in use and the average energy consumption for 1 year.

Note

The EU Energy Label will be ONLY applied on the models bundling with HDMI and TV tuners.



이 기기는 가정용 (B 급) 전자파 적합 기기로서 주로 가정에서 사용하는 것을 목적으로 하며, 모든 지역에서 사용할 수 있습니다.



VCCI-B

この装置は、クラス B 情報技術装置です。この装置は、家庭環境で使用することを目的としていますが、この装置がラジオやテレビジョン受信機に近接して使用されると、受信障害を引き起こすことがあります。取扱説明書に従って正しい取り扱いをして下さい。

粗分類	化学物質表					
	Pb	Hg	Cd	Cr6+	PBBs	PBDEs
前面ベゼル	0	0	0	0	0	0
背面カバー	0	0	0	0	0	0
スタンド	0	0	0	0	0	0
LCD パネル	WLED	適用除外の	0	0	0	0
	CCFL	適用除外の	適用除外の	0	0	0
PCBA	適用除外の	0	0	0	0	0
ケーブル & ワイヤ	適用除外の	0	0	0	0	0
リモコン	適用除外の	0	0	0	0	0

*: PCBA はベア印刷回路基板、で構成され、はんだ付けおよび抵抗器、コンデンサ、アレー、コネクタ、チップなど、その表面実装エレメントで構成されます。
 注1: 「0」は、計算される物質の含有率が参照含有率を超えていないことを示します。
 注2: 「適用除外」項目は、特定の化学物質が JIS C 0950 の規格により適用除外とされた項目に対応することを意味します。
 JIS C 0950

Restriction on Hazardous Substances statement (India)

This product complies with the "India E-waste Rule 2011" and prohibits use of lead, mercury, hexavalent chromium, polybrominated biphenyls or polybrominated diphenyl ethers in concentrations exceeding 0.1 weight % and 0.01 weight % for cadmium, except for the exemptions set in Schedule 2 of the Rule.

E-Waste Declaration for India



This symbol on the product or on its packaging indicates that this product must not be disposed of with your other household waste. Instead it is your responsibility to dispose of your waste equipment by handing it over to a designated collection point for the recycling of waste electrical and electronic equipment. The separate collection and recycling of your waste equipment at the time of disposal will help to conserve natural resources and ensure that it is recycled in a manner that protects human health and the environment. For more information about where you can drop off your waste equipment for recycling in India please visit the below web link.

<http://www.india.philips.com/about/sustainability/recycling/index.page>

Information for U.K. only

WARNING - THIS APPLIANCE MUST BE EARTHED.

Important:

This apparatus is supplied with an approved moulded 13A plug. To change a fuse in this type of plug proceed as follows:

1. Remove fuse cover and fuse.
2. Fit new fuse which should be a BS 1362 5A, A.S.T.A. or BSI approved type.
3. Retit the fuse cover.

If the fitted plug is not suitable for your socket outlets, it should be cut off and an appropriate 3-pin plug fitted in its place.

If the mains plug contains a fuse, this should have a value of 5A. If a plug without a fuse is used, the fuse at the distribution board should not be greater than 5A.

NOTE: The severed plug must be destroyed to avoid a possible shock hazard should it be inserted into a 13A socket elsewhere.

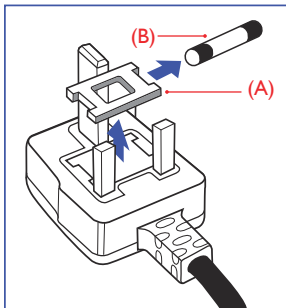

How to connect a plug

The wires in the mains lead are coloured in accordance with the following code:

BLUE - "NEUTRAL" ("N")

BROWN - "LIVE" ("L")

GREEN&YELLOW - "EARTH" ("E")

1. The GREEN&YELLOW wire must be connected to the terminal in the plug which is marked with the letter "E" or by the Earth symbol or coloured GREEN or GREEN&YELLOW.
2. The BLUE wire must be connected to the terminal which is marked with the letter "N" or coloured BLACK.
3. The BROWN wire must be connected to the terminal which is marked with the letter "L" or coloured RED.

Before replacing the plug cover, make certain that the cord grip is clamped over the sheath of the lead - not simply over the three wires.

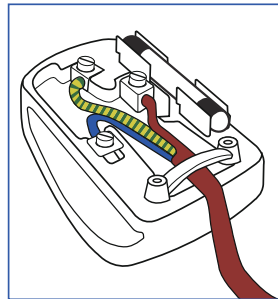

7. Customer care and warranty

7.1 Philips' Flat Panel Monitors Pixel Defect Policy

Philips strives to deliver the highest quality products. We use some of the industry's most advanced manufacturing processes and practice stringent quality control. However, pixel or sub pixel defects on the TFT Monitor panels used in flat panel monitors are sometimes unavoidable. No manufacturer can guarantee that all panels will be free from pixel defects, but Philips guarantees that any monitor with an unacceptable number of defects will be repaired or replaced under warranty. This notice explains the different types of pixel defects and defines acceptable defect levels for each type. In order to qualify for repair or replacement under warranty, the number of pixel defects on a TFT Monitor panel must exceed these acceptable levels. For example, no more than 0.0004% of the sub pixels on a monitor may be defective. Furthermore, Philips sets even higher quality standards for certain types or combinations of pixel defects that are more noticeable than others. This policy is valid worldwide.

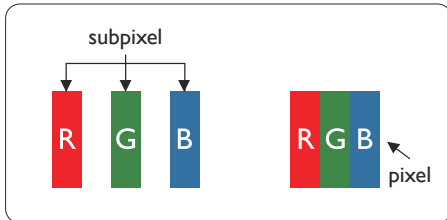

Pixels and Sub pixels

A pixel, or picture element, is composed of three sub pixels in the primary colors of red, green and blue. Many pixels together form an image. When all sub pixels of a pixel are lit, the three colored sub pixels together appear as a single colored pixel. When all are dark, the three colored sub pixels together appear as a single

black pixel. Other combinations of lit and dark sub pixels appear as single pixels of other colors.

Types of Pixel Defects

Pixel and sub pixel defects appear on the screen in different ways. There are two categories of pixel defects and several types of sub pixel defects within each category.

Bright Dot Defects

Bright dot defects appear as pixels or sub pixels that are always lit or 'on'. That is, a bright dot is a sub-pixel that stands out on the screen when the monitor displays a dark pattern. There are the types of bright dot defects.

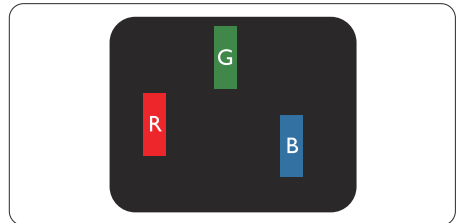

One lit red, green or blue sub pixel.

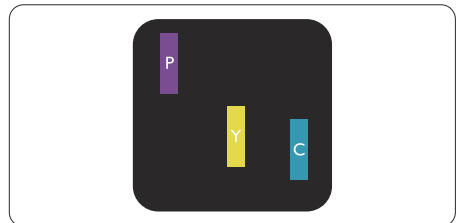

Two adjacent lit sub pixels:

- Red + Blue = Purple
- Red + Green = Yellow
- Green + Blue = Cyan (Light Blue)

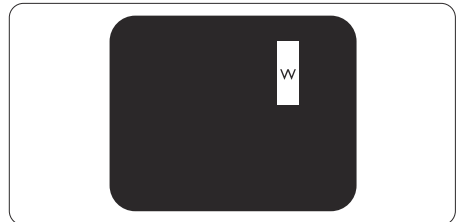

Three adjacent lit sub pixels (one white pixel).

Note

A red or blue bright dot must be more than 50 percent brighter than neighboring dots while a green bright dot is 30 percent brighter than neighboring dots.

Black Dot Defects

Black dot defects appear as pixels or sub pixels that are always dark or 'off'. That is, a dark dot is a sub-pixel that stands out on the screen when the monitor displays a light pattern. These are the types of black dot defects.

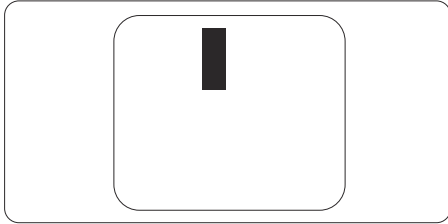

Proximity of Pixel Defects

Because pixel and sub pixels defects of the same type that are near to one another may be more noticeable, Philips also specifies tolerances for the proximity of pixel defects.

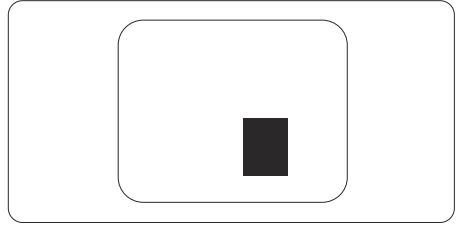

Pixel Defect Tolerances

In order to qualify for repair or replacement due to pixel defects during the warranty period, a TFT Monitor panel in a Philips flat panel monitor must have pixel or sub pixel defects exceeding the tolerances listed in the following tables.

BRIGHT DOT DEFECTS	ACCEPTABLE LEVEL
1 lit subpixel	3
2 adjacent lit subpixels	1
3 adjacent lit subpixels (one white pixel)	0
Distance between two bright dot defects*	>15mm
Total bright dot defects of all types	3
BLACK DOT DEFECTS	ACCEPTABLE LEVEL
1 dark subpixel	5 or fewer
2 adjacent dark subpixels	2 or fewer
3 adjacent dark subpixels	0
Distance between two black dot defects*	>15mm
Total black dot defects of all types	5 or fewer
TOTAL DOT DEFECTS	ACCEPTABLE LEVEL
Total bright or black dot defects of all types	5 or fewer

Note

- 1 or 2 adjacent sub pixel defects = 1 dot defect
- This monitor is ISO9241-307 compliant (ISO9241-307: Ergonomic requirement, analysis and compliance test methods for electronic visual displays)

7.2 Customer Care & Warranty

For warranty coverage information and additional support requirement valid for your region, please visit www.philips.com/support website for details. You may also contact your local Philips Customer Care Center number listed below.

Contact Information for WESTERN EUROPE region:

Country	CSP	Hotline Number	Price	Opening Hours
Austria	RTS	+43 0810 000206	€ 0.07	Mon to Fri : 9am - 6pm
Belgium	Ecare	+32 078 250851	€ 0.06	Mon to Fri : 9am - 6pm
Cyprus	Alman	800 92 256	Free of charge	Mon to Fri : 9am - 6pm
Denmark	Infocare	+45 3525 8761	Local call tariff	Mon to Fri : 9am - 6pm
Finland	Infocare	+358 09 2290 1908	Local call tariff	Mon to Fri : 9am - 6pm
France	Mainteq	+33 082161 1658	€ 0.09	Mon to Fri : 9am - 6pm
Germany	RTS	+49 01803 386 853	€ 0.09	Mon to Fri : 9am - 6pm
Greece	Alman	+30 00800 3122 1223	Free of charge	Mon to Fri : 9am - 6pm
Ireland	Celestica	+353 01 601 1161	Local call tariff	Mon to Fri : 8am - 5pm
Italy	Anovo Italy	+39 840 320 041	€ 0.08	Mon to Fri : 9am - 6pm
Luxembourg	Ecare	+352 26 84 30 00	Local call tariff	Mon to Fri : 9am - 6pm
Netherlands	Ecare	+31 0900 0400 063	€ 0.10	Mon to Fri : 9am - 6pm
Norway	Infocare	+47 2270 8250	Local call tariff	Mon to Fri : 9am - 6pm
Poland	MSI	+48 0223491505	Local call tariff	Mon to Fri : 9am - 6pm
Portugal	Mainteq	800 780 902	Free of charge	Mon to Fri : 8am - 5pm
Spain	Mainteq	+34 902 888 785	€ 0.10	Mon to Fri : 9am - 6pm
Sweden	Infocare	+46 08 632 0016	Local call tariff	Mon to Fri : 9am - 6pm
Switzerland	ANOVO CH	+41 02 2310 2116	Local call tariff	Mon to Fri : 9am - 6pm
United Kingdom	Celestica	+44 0207 949 0069	Local call tariff	Mon to Fri : 8am - 5pm

Contact Information for LATIN AMERICA region:

Country	Call center	Consumer care number
Brazil	Vermont	0800-7254101
Argentina		0800 3330 856

Contact Information for China:

Country	Call center	Consumer care number
China	PCCW Limited	4008 800 008

7. Customer care and warranty

Contact Information for CENTRAL AND EASTERN EUROPE region:

Country	Call center	CSP	Consumer care number
Belarus	N/A	IBA	+375 17 217 3386 +375 17 217 3389
Bulgaria	N/A	LAN Service	+359 2 960 2360
Croatia	N/A	MR Service Ltd	+385 (01) 640 1111
Czech Rep.	N/A	Asupport	420 272 188 300
Estonia	N/A	FUJITSU	+372 6519900(General) +372 6519972(workshop)
Georgia	N/A	Esabi	+995 322 91 34 71
Hungary	N/A	Profi Service	+36 1 814 8080(General) +36 1814 8565(For AOC&Philips only)
Kazakhstan	N/A	Classic Service I.l.c.	+7 727 3097515
Latvia	N/A	ServiceNet LV	+371 67460399 +371 27260399
Lithuania	N/A	UAB Servicenet	+370 37 400160(general) +370 7400088 (for Philips)
Macedonia	N/A	AMC	+389 2 3125097
Moldova	N/A	Comel	+37322224035
Romania	N/A	Skin	+40 21 2101969
Russia	N/A	CPS	+7 (495) 645 6746
Serbia&Montenegro	N/A	Kim Tec d.o.o.	+381 11 20 70 684
Slovakia	N/A	Datalan Service	+421 2 49207155
Slovenia	N/A	PC H.and	+386 1 530 08 24
the republic of Belarus	N/A	ServiceBy	+375 17 284 0203
Turkey	N/A	Tecpro	+90 212 444 4 832
Ukraine	N/A	Topaz	+38044 525 64 95
Ukraine	N/A	Comel	+380 5627444225

Contact Information for NORTH AMERICA:

Country	Call center	Consumer care number
U.S.A.	EPI-e-center	(877) 835-1838
Canada	EPI-e-center	(800)479-6696

7. Customer care and warranty

Contact Information for APMEA region:

Country	ASP	Consumer care number	Opening hours
Armenia Azerbaijan Georgia Kyrgyzstan Tajikistan	Firebird service centre	+97 14 8837911	Sun.~Thu. 09:00 - 18:00
Australia	AGOS NETWORK PTY LTD	1300 360 386	Mon.~Fri. 9:00am-5:30pm
Hong Kong Macau	Company: Smart Pixels Technology Ltd.	Hong Kong: Tel: +852 2619 9639 Macau: Tel: (853)-0800-987	Mon.~Fri. 9:00am-6:00pm Sat. 9:00am-1:00pm
India	REDINGTON INDIA LTD	Tel: 1 800 425 6396 SMS: PHILIPS to 56677	Mon.~Fri. 9:00am-5:30pm
Indonesia	PT. CORMIC SERVISINDO PERKASA	+62-21-4080-9086 (Customer Hotline) +62-8888-01-9086 (Customer Hotline)	Mon.~Thu. 08:30-12:00; 13:00-17:30 Fri. 08:30-11:30; 13:00-17:30
Israel	Eastronics LTD	1-800-567000	Sun.~Thu. 08:00-18:00
Korea	Alphascan Displays, Inc	1661-5003	Mon.~Fri. 9:00am-5:30pm Sat. 9:00am-1:00pm
Malaysia	R-Logic Sdn Bhd	+603 5102 3336	Mon.~Fri. 8:15am-5:00pm Sat. 8:30am-12:30am
New Zealand	Visual Group Ltd.	0800 657447	Mon.~Fri. 8:30am-5:30pm
Pakistan	TVONICS Pakistan	+92-213-6030100	Sun.~Thu. 10:00am-6:00pm
Philippines	EA Global Supply Chain Solutions ,Inc.	(02) 655-7777; 6359456	Mon.~Fri. 8:30am~5:30pm
Singapore	Philips Singapore Pte Ltd (Philips Consumer Care Center)	(65) 6882 3966	Mon.~Fri. 9:00am-6:00pm Sat. 9:00am-1:00pm
South Africa	Computer Repair Technologies	011 262 3586	Mon.~ Fri. 08:00am~05:00pm

7. Customer care and warranty

Taiwan	FETEC.CO	0800-231-099	Mon.~Fri. 09:00 - 18:00
Thailand	Axis Computer System Co., Ltd.	(662) 934-5498	Mon.~Fri. 08:30am~05:30pm
Turkmenistan	Technostar Service Centre	+(99312) 460733, 460957	Mon.~Fri. 09:00 - 18:00
Uzbekistan	Soniko Plus Private Enterprise Ltd	+99871 2784650	Mon.~Fri. 09:00 - 18:00
Vietnam	FPT Service Informatic Company Ltd. - Ho Chi Minh City Branch	+84 8 38248007 Ho Chi Minh City +84 5113.562666 Danang City +84 5113.562666 Can tho Province	Mon.~Fri. 8:00-12:00, 13:30-17:30 Sat. 8:00-12:00
Japan	フィリップスモニター・サポートセンター	0120-060-530	Mon.~Fri. 10:00 - 17:00

8. Troubleshooting & FAQs

8.1 Troubleshooting

This page deals with problems that can be corrected by a user. If the problem still persists after you have tried these solutions, contact Philips customer service representative.

1 Common Problems

No Picture (Power LED not lit)

- Make sure the power cord is plugged into the power outlet and into the back of the monitor.
- First, ensure that the power button on the front of the monitor is in the OFF position, then press it to the ON position.

No Picture (Power LED is White)

- Make sure the computer is turned on.
- Make sure the signal cable is properly connected to your computer.
- Make sure the monitor cable has no bent pins on the connect side. If yes, repair or replace the cable.
- The Energy Saving feature may be activated

Screen says

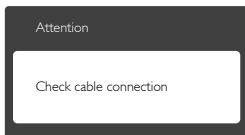

- Make sure the monitor cable is properly connected to your computer: (Also refer to the Quick Start Guide).
- Check to see if the monitor cable has bent pins.
- Make sure the computer is turned on.

AUTO button doesn't function

- The auto function is applicable only in VGA-Analog mode. If the result is not

satisfactory, you can do manual adjustments via the OSD menu.

Note

The Auto Function is not applicable in DVI-Digital mode as it is not necessary.

Visible signs of smoke or sparks

- Do not perform any troubleshooting steps
- Disconnect the monitor from mains power source immediately for safety
- Contact with Philips customer service representative immediately.

2 Imaging Problems

Image is not centered

- Adjust the image position using the "Auto" function in OSD Main Controls.
- Adjust the image position using the Phase/Clock of Setup in OSD Main Controls. It is valid only in VGA mode.

Image vibrates on the screen

- Check that the signal cable is properly securedly connected to the graphics board or PC.

Vertical flicker appears



- Adjust the image using the "Auto" function in OSD Main Controls.
- Eliminate the vertical bars using the Phase/Clock of Setup in OSD Main Controls. It is valid only in VGA mode.

Horizontal flicker appears



- Adjust the image using the "Auto" function in OSD Main Controls.

- Eliminate the vertical bars using the Phase/Clock of Setup in OSD Main Controls. It is valid only in VGA mode.

Image appears blurred, indistinct or too dark

- Adjust the contrast and brightness on On-Screen Display.

An "after-image", "burn-in" or "ghost image" remains after the power has been turned off.

- Uninterrupted display of still or static images over an extended period may cause "burn in", also known as "after-imaging" or "ghost imaging", on your screen. "Burn-in", "after-imaging", or "ghost imaging" is a well-known phenomenon in LCD panel technology. In most cases, the "burned in" or "after-imaging" or "ghost imaging" will disappear gradually over a period of time after the power has been switched off.
- Always activate a moving screen saver program when you leave your monitor unattended.
- Always activate a periodic screen refresh application if your LCD monitor will display unchanging static content.
- Failure to activate a screen saver, or a periodic screen refresh application may result in severe "burn-in" or "after-image" or "ghost image" symptoms that will not disappear and cannot be repaired. The damage mentioned above is not covered under your warranty.

Image appears distorted. Text is fuzzy or blurred.

- Set the PC's display resolution to the same mode as monitor's recommended screen native resolution.

Green, red, blue, dark, and white dots appears on the screen

- The remaining dots are normal characteristic of the liquid crystal used in today's technology, Please refer the pixel policy for more detail.

The "power on" light is too strong and is

disturbing

- You can adjust "power on" light using the power LED Setup in OSD main Controls.

For further assistance, refer to the Consumer Information Centers list and contact Philips customer service representative.

8.2 SmartControl Lite FAQs

Q1. I change the monitor on a PC to a different one and the SmartControl Lite becomes un-usable, what do I do?

Ans.: Restart your PC and see if SmartControl Lite can work. Otherwise, you will need to remove and re-install SmartControl Lite to ensure proper driver is installed.

Q2. The SmartControl Lite functions worked well before, but it does not work anymore, what can I do?

Ans.: If the following actions were executed, the monitor driver may need to be re-installed.

- Changed video graphic adapter to another one
- Updated video driver
- Activities on OS, such as service pack or patch
- Run Windows Update and updated monitor and/or video driver
- Windows was booted with the monitor power off or disconnected.
- To find out, please right click My Computer and click on Properties->Hardware->Device Manager:
- If you see "Plug and Play Monitor" shows under Monitor; then you need to re-install. Simply remove SmartControl Lite and re-install it.

Q3. After installing SmartControl Lite, when clicking on SmartControl Lite tab, nothing shows up after a while or a failure message shows, what happened?

Ans.: It might be your graphic adaptor is not

compatible with the SmartControl Lite. If your graphic adaptor is one of the above mentioned brands, try to download the most updated graphic adaptor driver from corresponding companies' web site. Install the driver: Remove SmartControl Lite, and re-install it once more. If it is still not working, we are sorry that the graphic adaptor is not supported. Please visit Philips website and check if an updated SmartControl Lite driver is available.

Q4. When I click on Product Information, only partial information is shown, what happened?

Ans.: It might be your graphic card adaptor driver is not the most updated version which fully supporting DDC/CI interface. Please try to download the most updated graphic adaptor driver from corresponding companies' web site. Install the driver: Remove SmartControl Lite and re-install it once more.

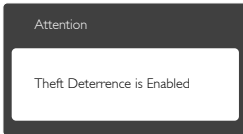

Q5. I forgot my PIN for Theft Deterrence Function. What can I do?

Ans.: Philips Service center has a right to ask for legitimate identification and authorization, in order to establish ownership of the monitor. Please note that the anti-theft deterrence function is provided as a convenient free option. Managing PIN numbers is the sole responsibility of the individual user or the organization who sets it. In case the PIN number is forgotten, Philips service center can re-set it for you at a nominal charge after verification of ownership. Please note that this activity is not covered by standard warranty terms.

8.3 General FAQs

Q1: When I install my monitor what should I do if the screen shows 'Cannot display this video mode'?

Ans.: Recommended resolution for this monitor: 1920x1080@60Hz.

- Unplug all cables, then connect your PC to the monitor that you used previously.
- In the Windows Start Menu, select Settings/ Control Panel. In the Control Panel Window, select the Display icon. Inside the Display Control Panel, select the 'Settings' tab. Under the setting tab, in box labelled 'desktop area', move the sidebar to 1920x1080 pixels.
- Open 'Advanced Properties' and set the Refresh Rate to 60Hz, then click OK.
- Restart your computer and repeat step 2 and 3 to verify that your PC is set at 1920x1080@60Hz.
- Shut down your computer, disconnect your old monitor and reconnect your Philips LCD monitor.
- Turn on your monitor and then turn on your PC.

Q2: What is the recommended refresh rate for LCD monitor?

Ans.: Recommended refresh rate in LCD monitors is 60Hz, In case of any disturbance on screen, you can set it up to 75Hz to see if that removes the disturbance.

Q3: What are the .inf and .icm files on the CD-ROM? How do I install the drivers (.inf and .icm)?

Ans.: These are the driver files for your monitor. Follow the instructions in your user manual to install the drivers. Your computer may ask you for monitor drivers (.inf and .icm files) or a driver disk when you first install your monitor. Follow the instructions to insert the (companion CD-ROM) included in this package.

Monitor drivers (.inf and .icm files) will be installed automatically.

Q4: How do I adjust the resolution?

Ans.: Your video card/graphic driver and monitor together determine the available resolutions. You can select the desired resolution under Windows® Control Panel with the "Display properties".

Q5: What if I get lost when I am making monitor adjustments via OSD?

Ans.: Simply press the **OK** button, then select 'Reset' to recall all of the original factory settings.

Q6: Is the LCD screen resistant to scratches?

Ans.: In general it is recommended that the panel surface is not subjected to excessive shocks and is protected from sharp or blunt objects. When handling the monitor, make sure that there is no pressure or force applied to the panel surface side. This may affect your warranty conditions.

Q7: How should I clean the LCD surface?

Ans.: For normal cleaning, use a clean, soft cloth. For extensive cleaning, please use isopropyl alcohol. Do not use other solvents such as ethyl alcohol, ethanol, acetone, hexane, etc.

Q8: Can I change the color setting of my monitor?

Ans.: Yes, you can change your color setting through OSD control as the following procedures,

- Press "OK" to show the OSD (On Screen Display) menu
- Press "Down Arrow" to select the option "Color" then press "OK" to enter color setting, there are three settings as below.
 1. Color Temperature; With settings in the 6500K range the panel appears "warm, with a red-white color tone", while a 9300K temperature yields "cool, blue-white toning".

2. sRGB; this is a standard setting for ensuring correct exchange of colors between different device (e.g. digital cameras, monitors, printers, scanners, etc)
3. User Define; the user can choose his/her preference color setting by adjusting red, green blue color:

 **Note**

A measurement of the color of light radiated by an object while it is being heated. This measurement is expressed in terms of absolute scale, (degrees Kelvin). Lower Kelvin temperatures such as 2004K are red; higher temperatures such as 9300K are blue. Neutral temperature is white, at 6504K.

Q9: Can I connect my LCD monitor to any PC, workstation or Mac?

Ans.: Yes. All Philips LCD monitors are fully compatible with standard PCs, Macs and workstations. You may need a cable adapter to connect the monitor to your Mac system. Please contact your Philips sales representative for more information.

Q10: Are Philips LCD monitors Plug-and-Play?

Ans.: Yes, the monitors are Plug-and-Play compatible with Windows 8/7/Vista/XP/NT, Mac OSX, Linux

Q11: What is Image Sticking, or Image Burn-in, or After Image, or Ghost Image in LCD panels?

Ans.: Uninterrupted display of still or static images over an extended period may cause "burn in", also known as "after-imaging" or "ghost imaging", on your screen. "Burn-in", "after-imaging", or "ghost imaging" is a well-known phenomenon in LCD panel technology. In most cases, the "burned in" or "after-imaging" or "ghost imaging" will disappear gradually over a period of time after the power has been switched off.
Always activate a moving screen saver

8. Troubleshooting & FAQs

program when you leave your monitor unattended.

Always activate a periodic screen refresh application if your LCD monitor will display unchanging static content.

Warning

Severe "burn-in" or "after-image" or "ghost image" symptoms will not disappear and cannot be repaired. The damage mentioned above is not covered under your warranty.

Q12: Why is my Display not showing sharp text, and is displaying jagged characters?

Ans.: Your LCD monitor works best at its native resolution of 1920x1080@60Hz. For best display, please use this resolution.

Q13: How to unlock/lock my hot key?

Ans.: Please press /OK for 10 seconds to unlock/lock the hot key, by doing so, your monitor pops out "Attention" to show the unlock/lock status as shown below illustrators.

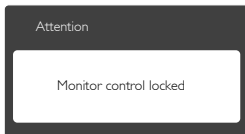
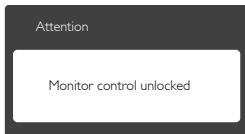

8.4 MHL FAQs

Q1: I cannot see my mobile device image on the monitor screen

Ans.:

- Please check if your mobile device is MHL certified.
- You also need to have a MHL certified cable to connect the devices.
- Make sure that you have connected to the MHL-HDMI port, and that correct input

is selected on the Monitor via the input selector (front bezel or OSD)

- The product is officially MHL-certified. As this monitor is a passive display, if you encounter any unexpected troubles when using the MHL input, please refer to the mobile device's user manual or contact the manufacturer of the mobile device.

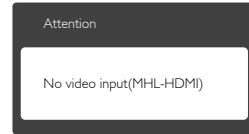

- Make sure your mobile device has not entered standby (sleep) mode. If it has, then you will see a notification message on the display. Once the mobile device wakes up, the monitor's display will wake and show the images. You may need to make sure that the correct input is selected if in between you have used or connected any other device

Q2. Why is the image on the monitor display of poor quality? My mobile device looks far better.

Ans.:

- The MHL standard defines fixed 1080p@30hz for output, and input. This monitor complies with this standard.
- The image quality depends on the quality of the original contents. If the content is of high resolution (example HD or 1080p), then it will appear in HD or 1080p on this monitor display. If the original content is in low resolution (example QVGA) it may look good on the mobile device due to its small screen size, but will look to be of lower quality on the large screen monitor display.

Q3. I cannot hear sound from the monitor display.

Ans.:

- Make sure your monitor display has built-in speakers and the volume is turned on the monitor side, and also on the mobile device side. You may also want to use optional headphones.
- If your monitor display does not have in built speakers, then you can connect optional headphones to the output on the monitor. Please ensure that the volume is turned on the monitor side, and also on the mobile device side.

For further information or FAQ, please visit official website of MHL org:

<http://www.mhlconsortium.org>



© 2014 Koninklijke Philips N.V. All rights reserved.

Philips and the Philips Shield Emblem are registered trademarks of Koninklijke Philips N.V. and are used under license from Koninklijke Philips N.V.

Specifications are subject to change without notice.

Version: M6247E2T