

4

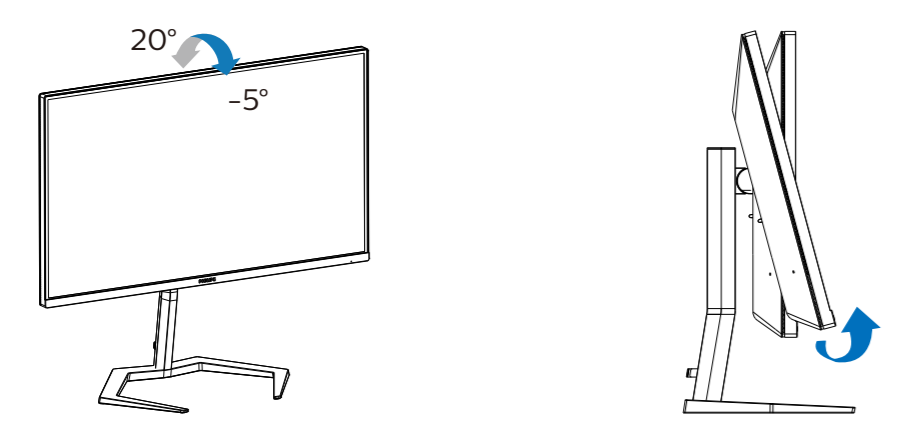

Earphone-Hang

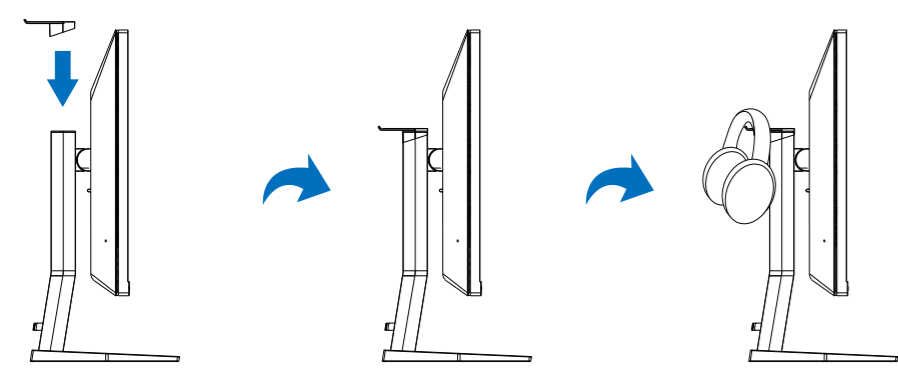

Register your product and get support at [www.philips.com/support](http://www.philips.com/support)

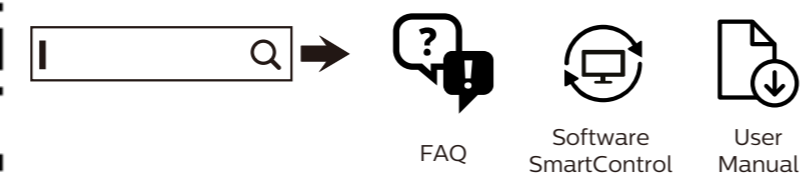

Version: 32MIN5500QIT  
2021 © TOP Victory Investments Ltd. All rights reserved.  
This product has been manufactured by and is sold under the responsibility of Top Victory Investments Ltd. and Top Victory Investments Ltd. is the warrantor in relation to this product.  
Philips and the Philips Shield Emblem are registered trademarks of Koninklijke Philips N.V. and are used under license.

Energy Labelling  
32MIN5500VS



Specifications are subject to change without notice.

**HDMI**

The terms HDMI, HDMI High-Definition Multimedia Interface, and the HDMI Logo are trademarks or registered trademarks of HDMI Licensing Administrator, Inc.

[www.philips.com](http://www.philips.com)



**PHILIPS**  
Gaming Monitor  
Momentum 5000



32MIN5500VS

# Quick start

Register your product and get support at [www.philips.com/welcome](http://www.philips.com/welcome)

## Contents

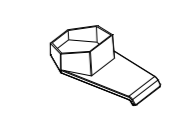
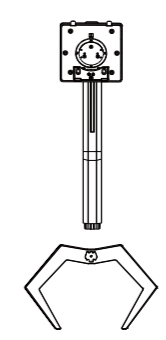
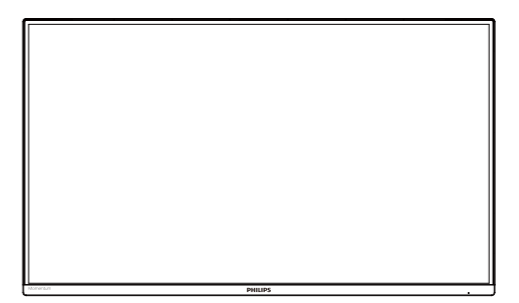

\* Earphone-Hang

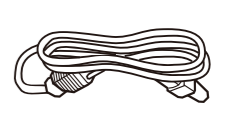

Power

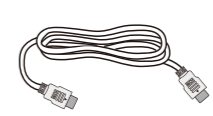

\*HDMI

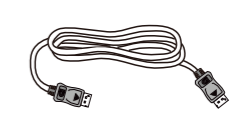

\*DP

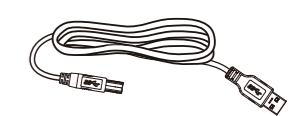

\* USB A-B

\*Different according to region  
Display design may differ from that illustrated

1

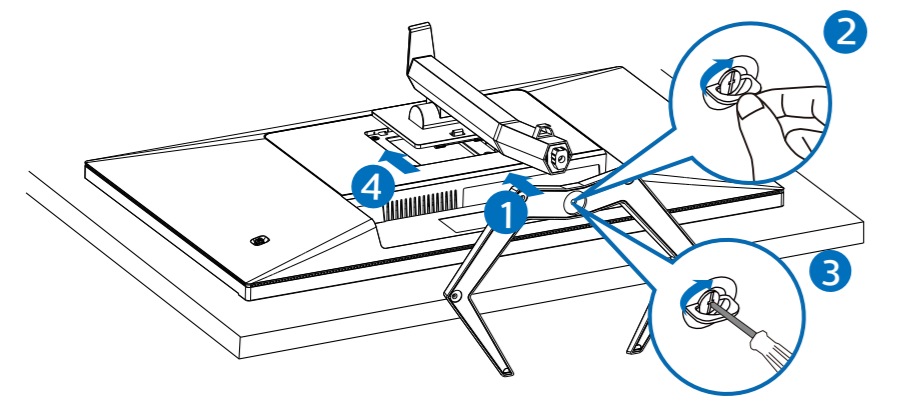

▲ CAUTION: Place the monitor face down on a smooth surface. Pay attention not to scratch or damage the screen.

2

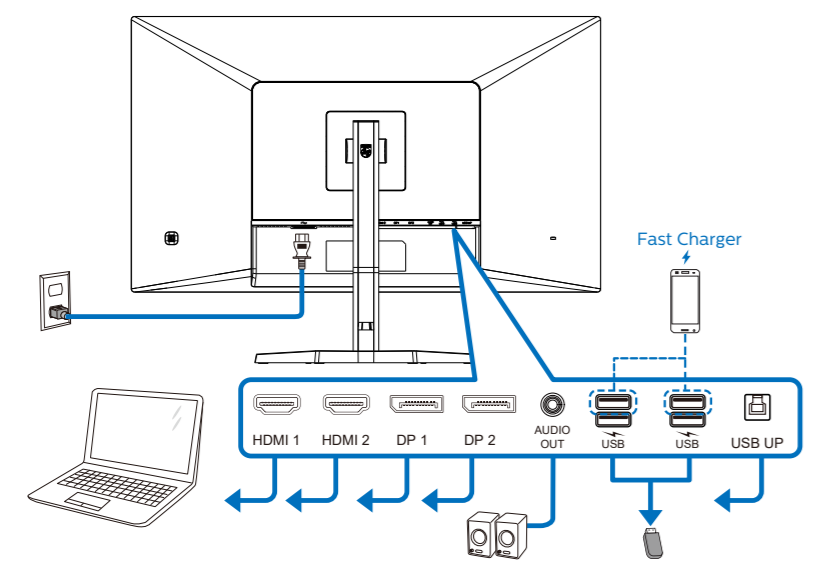

USB hub

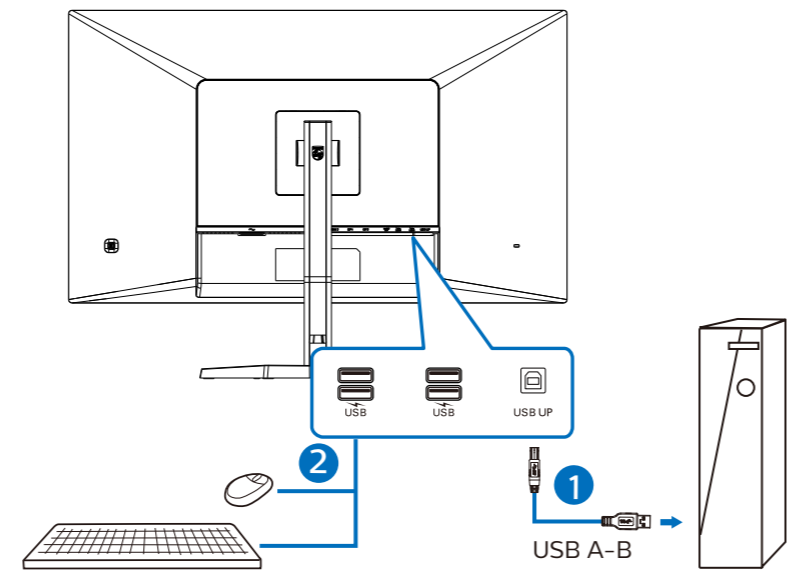

3

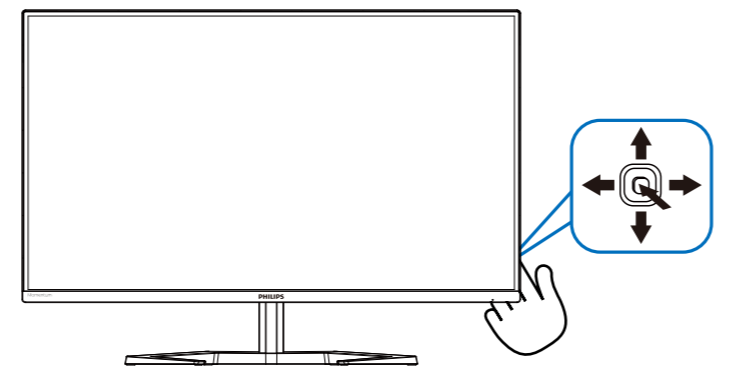

Game Setting	Adaptive Sync	On
	MPRT	Off
LowBlue Mode	MPRT Level	0
	Crosshair	Off
Input	Low Input Lag	On
	SmartResponse	Off
Picture	SmartFrame	Off
SmartSize		
Audio		



Game Setting	Adaptive Sync	On
	MPRT	Off
LowBlue Mode	MPRT Level	0
	Crosshair	Off
Input	Low Input Lag	On
	SmartResponse	Off
Picture	SmartFrame	Off
SmartSize		
Audio		



SmartImage™	HDR Game	
FPS	HDR Movie	
Racing	HDR Photo	
RTS	DisplayHDR 400	
Gamer 1	Personal	
Gamer 2		
LowBlue Mode		
EasyRead		
SmartUniformity		
Off		

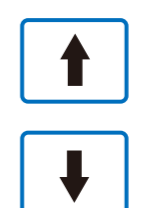
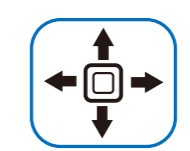

Game Setting	Adaptive Sync	On
	MPRT	Off
LowBlue Mode	MPRT Level	0
	Crosshair	Off
Input	Low Input Lag	On
	SmartResponse	Off
Picture	SmartFrame	Off
SmartSize		
Audio		



Game Setting	Adaptive Sync	On
	MPRT	Off
LowBlue Mode	MPRT Level	0
	Crosshair	Off
Input	Low Input Lag	On
	SmartResponse	Off
Picture	SmartFrame	Off
SmartSize		
Audio		



Game Setting	Adaptive Sync	On
	MPRT	Off
LowBlue Mode	MPRT Level	0
	Crosshair	Off
Input	Low Input Lag	On
	SmartResponse	Off
Picture	SmartFrame	Off
SmartSize		
Audio		